



SHEETPRESS GRAPHIC CIRCUIT

Front Panel

Back Panel

Top Plate

Bottom Plate

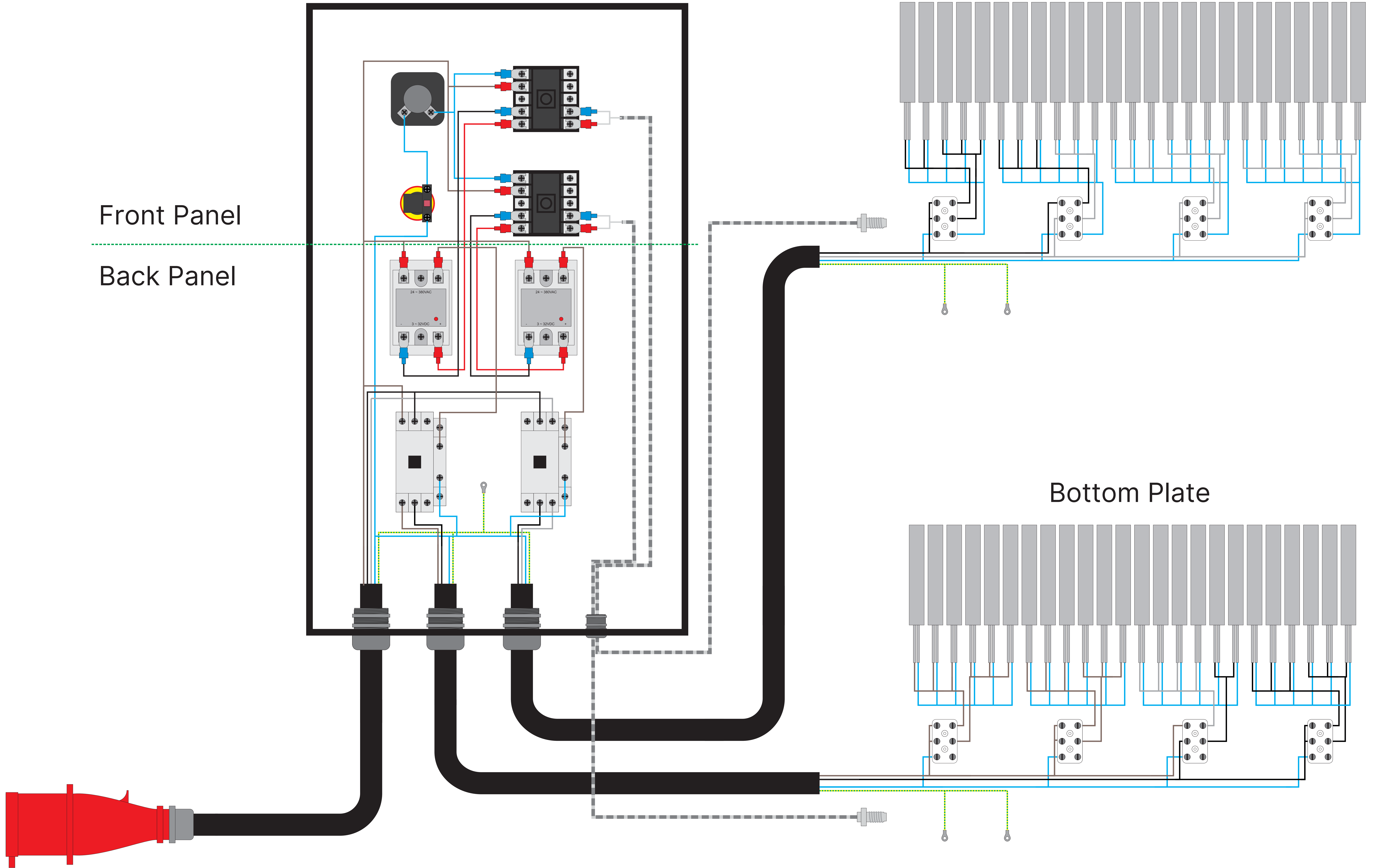

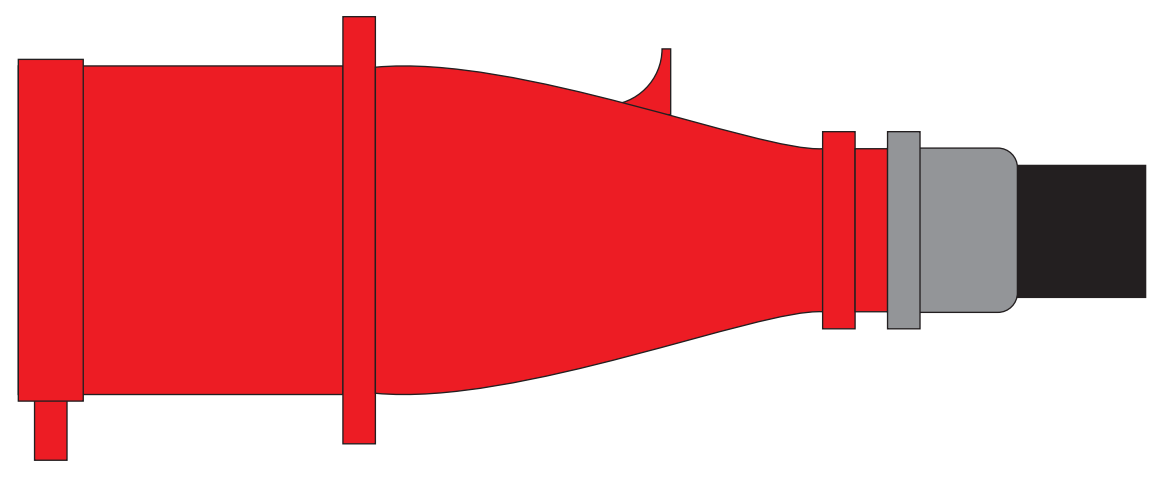

32A Male Plug

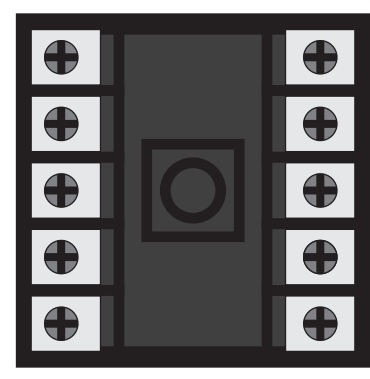

PID Controller

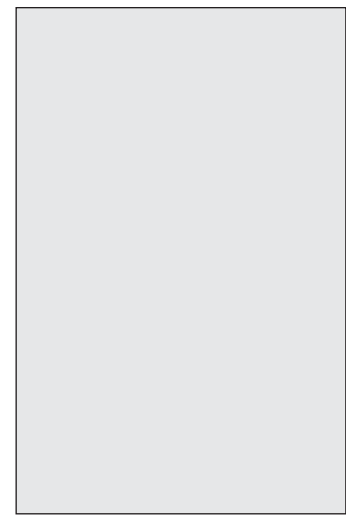

SSR Heat Sink

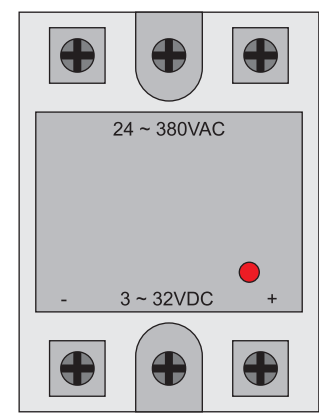

SSR 40A

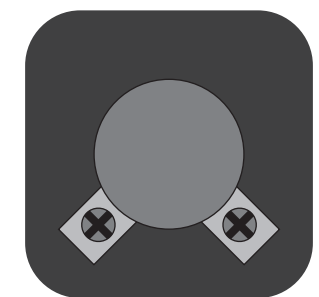

Rotary Switch

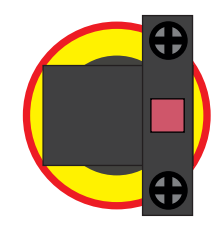

Emergency Stop

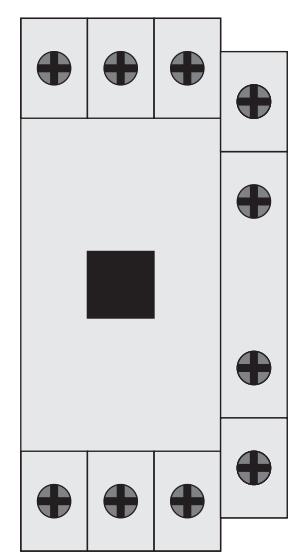

32A Circuit Breaker Relay



300W Cartridge Heater

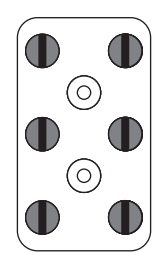

Ceramic Terminal



K Type Termocouple

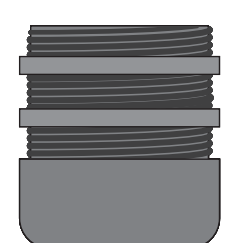

M25 Cable Gland

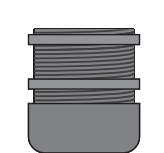

M10 Cable Gland

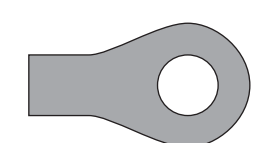

Ring Terminal



6MM 5 Multi-Core Cable

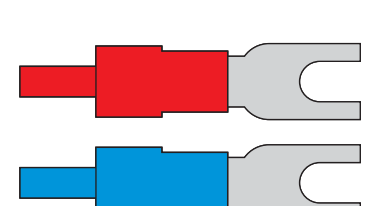

Fork Terminal